



PS23

**Sistema scorrevole
per ante a libro**

Sliding system for
folding doors





PS23

Sistema scorrevole per ante a libro
Sliding system for folding doors

Accessori complementari
Additional accessories

- **PR20 - Ante in alluminio.**
PR20 - Aluminium doors
- **BR - Raddrizza ante.**
BR - Doors Straightener.

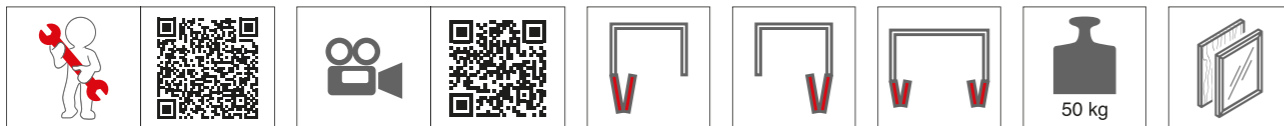

PS23, la semplicità è la chiave per il successo.

PS23, simplicity is the key to success.

■ PS23 - 25

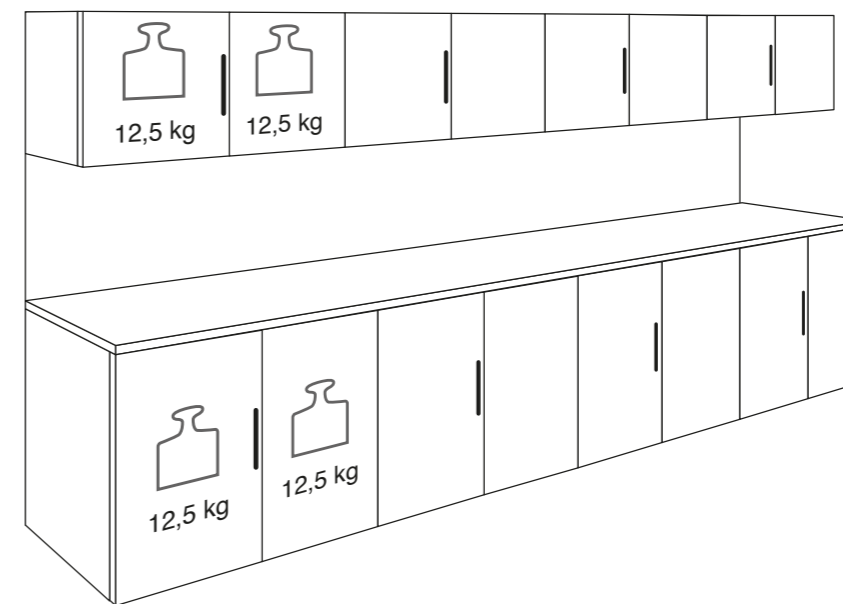

■ PS23 - 50

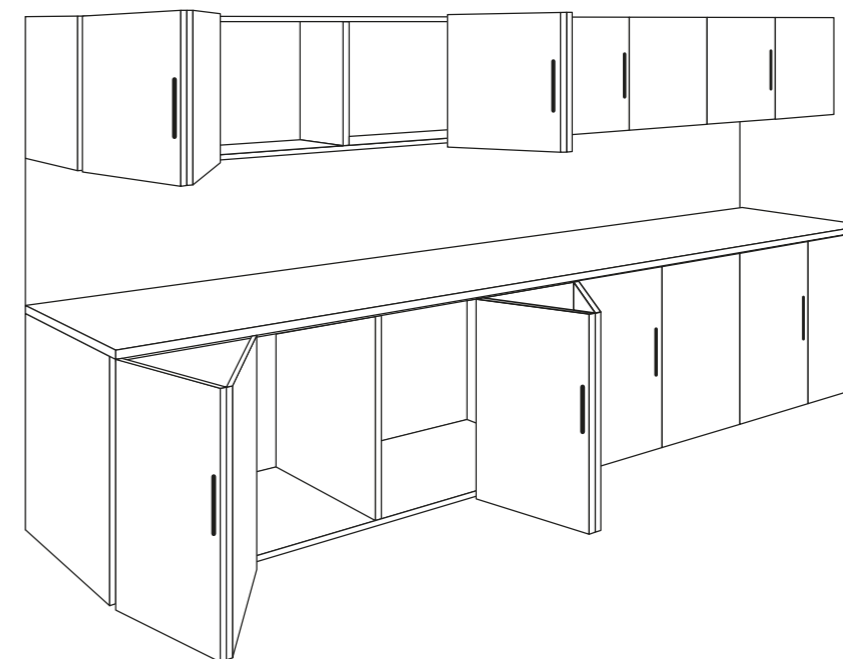
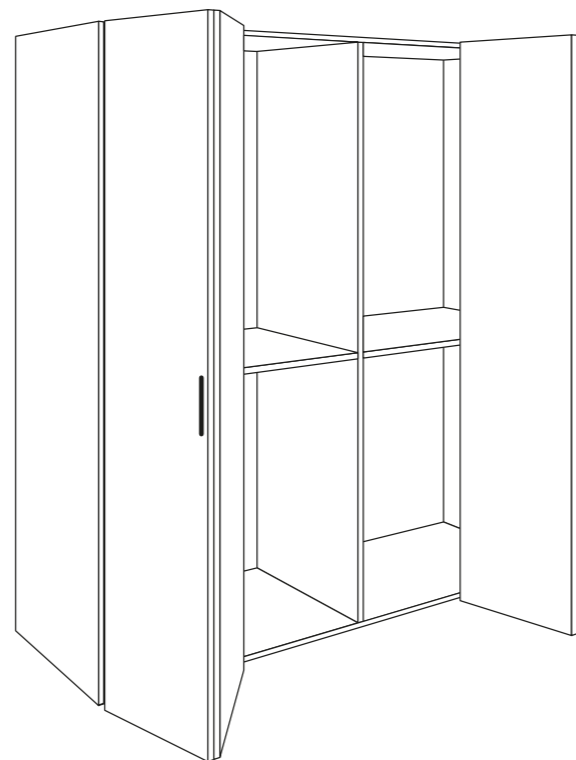
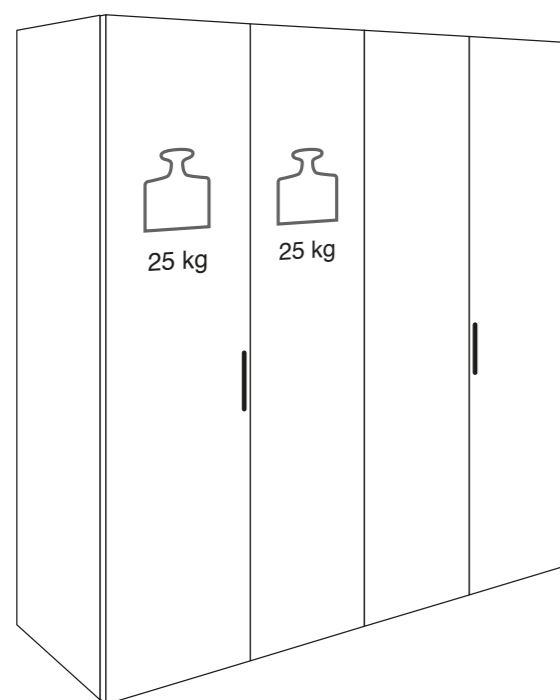

PS23

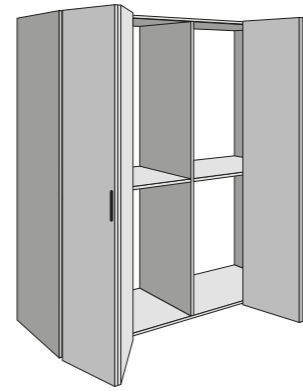

■ **Cerniere laterali standard.**
Standard side hinges.

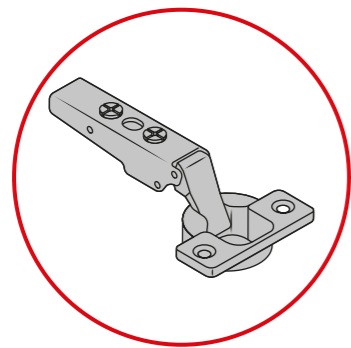
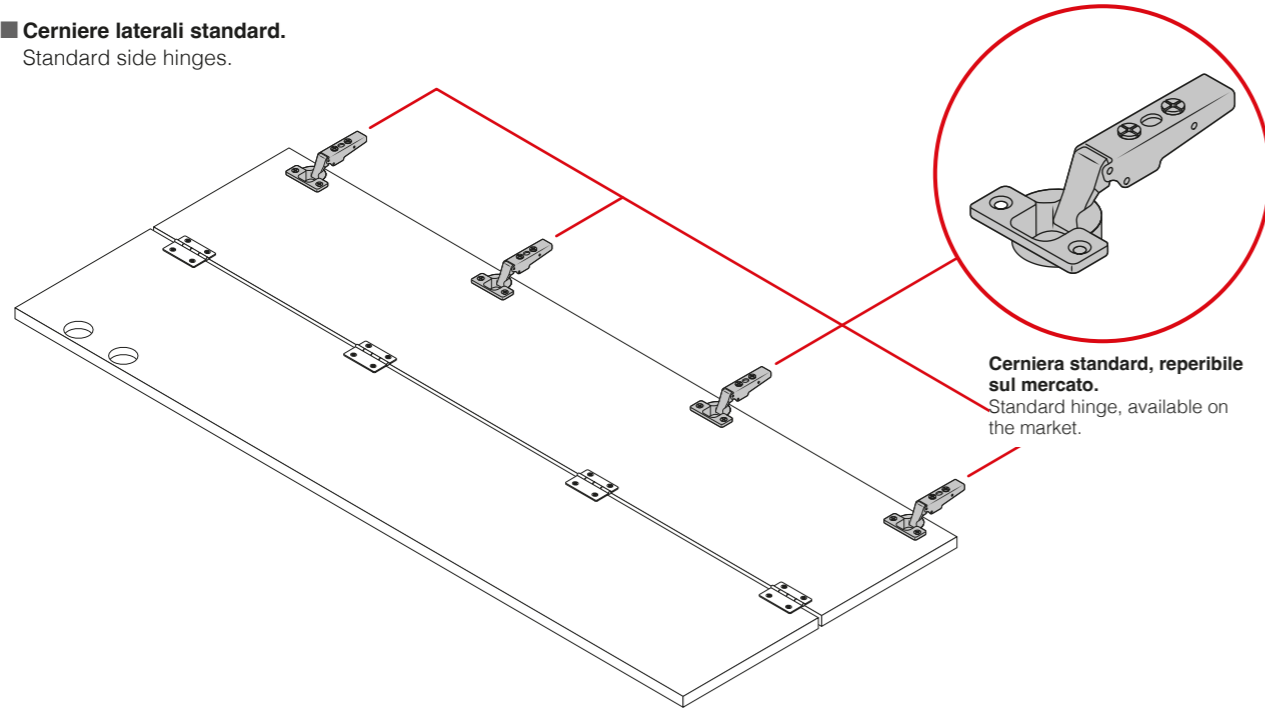

SOFT-CLOSING
L'effetto "soft-closing" si ottiene usando cerniere ammortizzate.
SOFT-CLOSING
"Soft-closing" effect simply using "soft-closing" hinges.

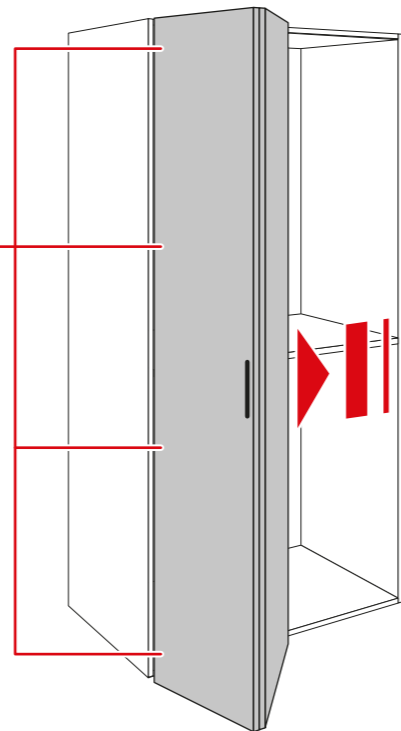

PS23. Schede tecniche / Data sheets

■ **Massima stabilità.**
Maximum stability.

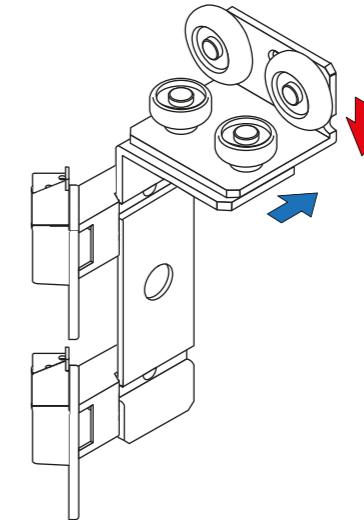
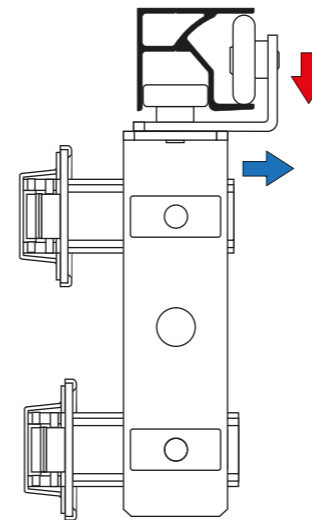

↓ **Forza verticale**
Vertical force
→ **Forza orizzontale**
Horizontal force

■ **Cover.**
Cover.

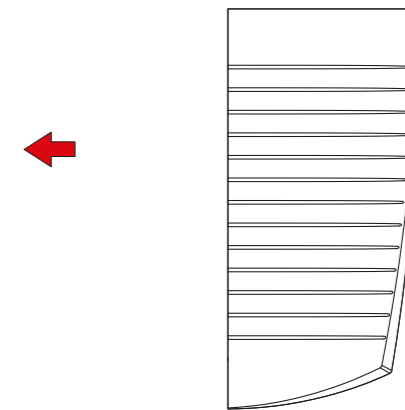
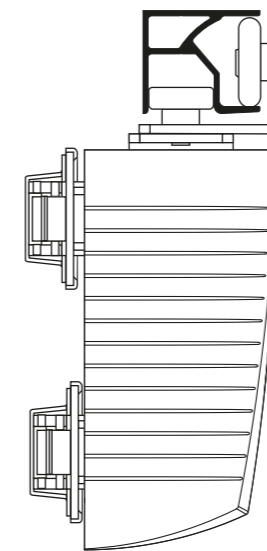

PS23 - 50

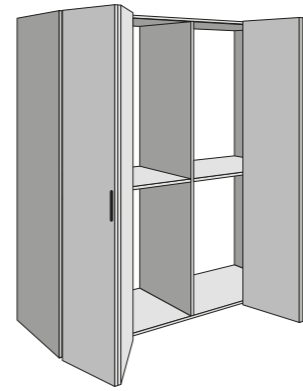
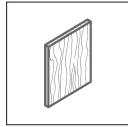

■ **Senza binario inferiore.**
Without lower rail.

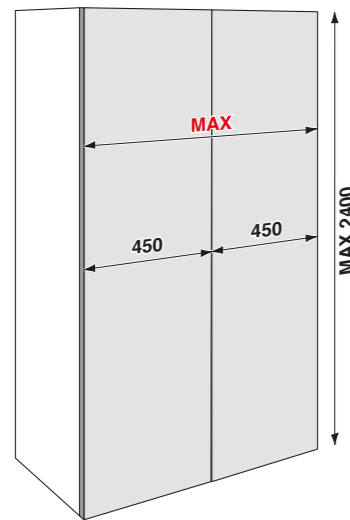

■ **Con binario inferiore.**
With lower rail.

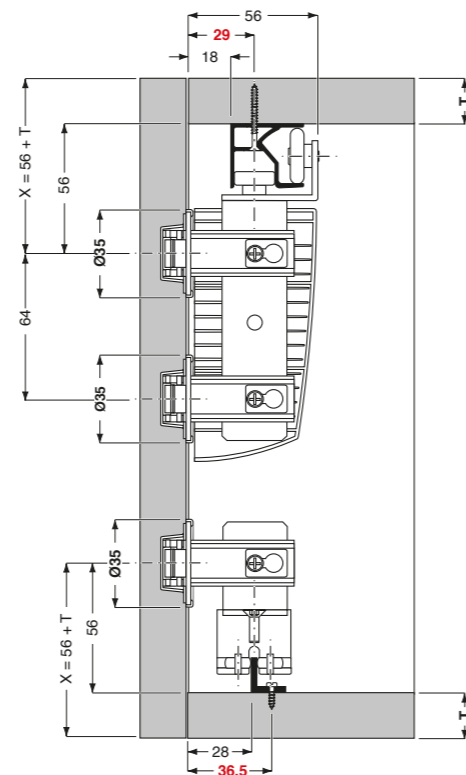
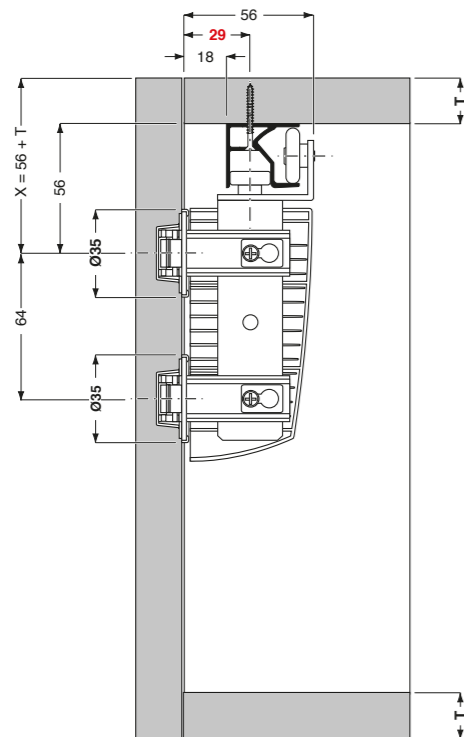
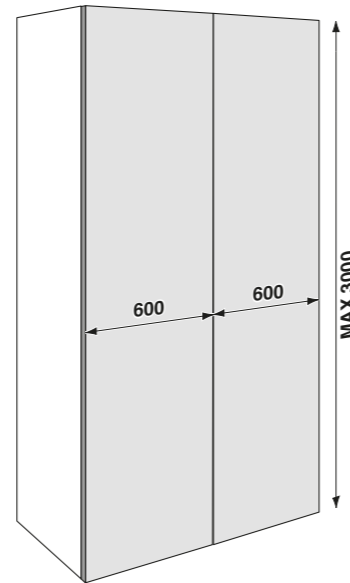

PS23. Schede tecniche / Data sheets

■ **Cerniere centrali standard.**
Standard central hinges.

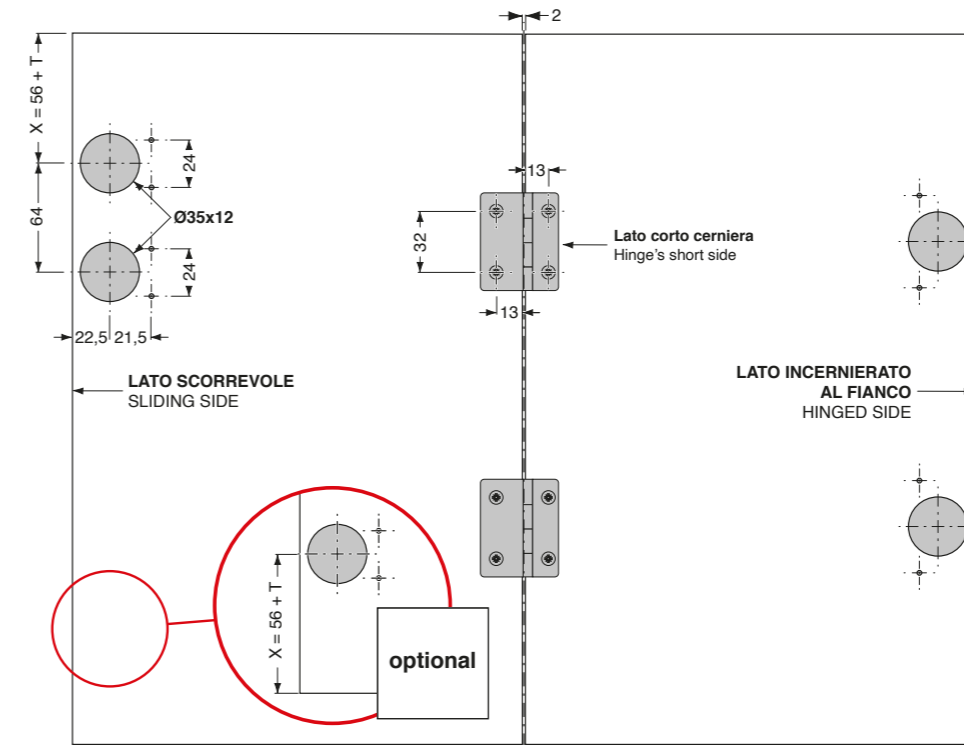

option
1

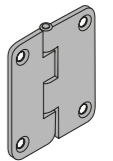

CL01105042

ABBREVIAZIONI:
T = spessore fondo/cappello
ABBREVIATIONS:
T = top / bottom panel thickness

■ **Cerniere centrali regolabili.**
Adjustable central hinges.

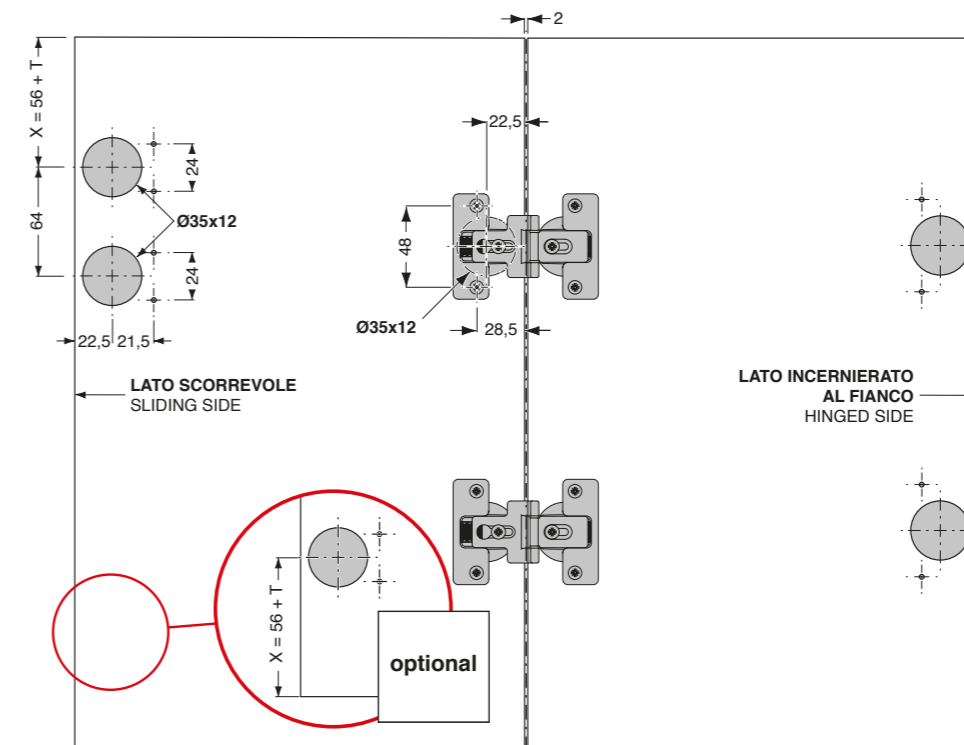

option
2

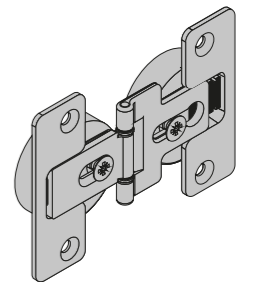

CL01420035

PS23 - 25

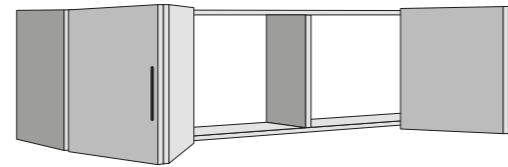
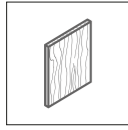

■ **Senza binario inferiore.**
Without lower rail.

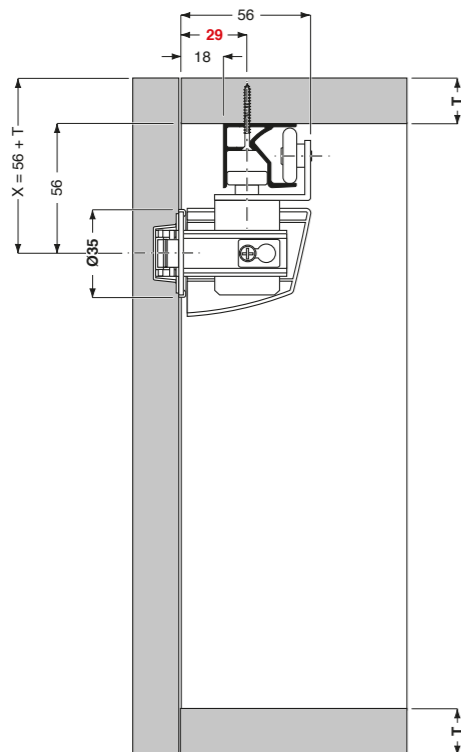
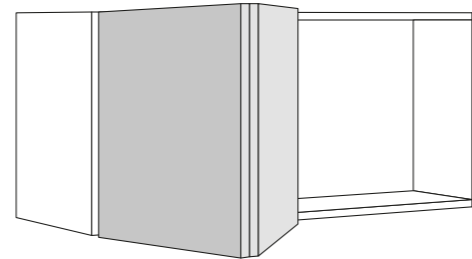
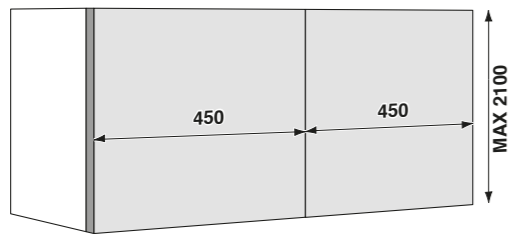

! **Rispettare rigorosamente i limiti di peso.**
Carefully respect the weight limit.

PS23. Schede tecniche / Data sheets

■ **Cerniere centrali standard.**
Standard central hinges.

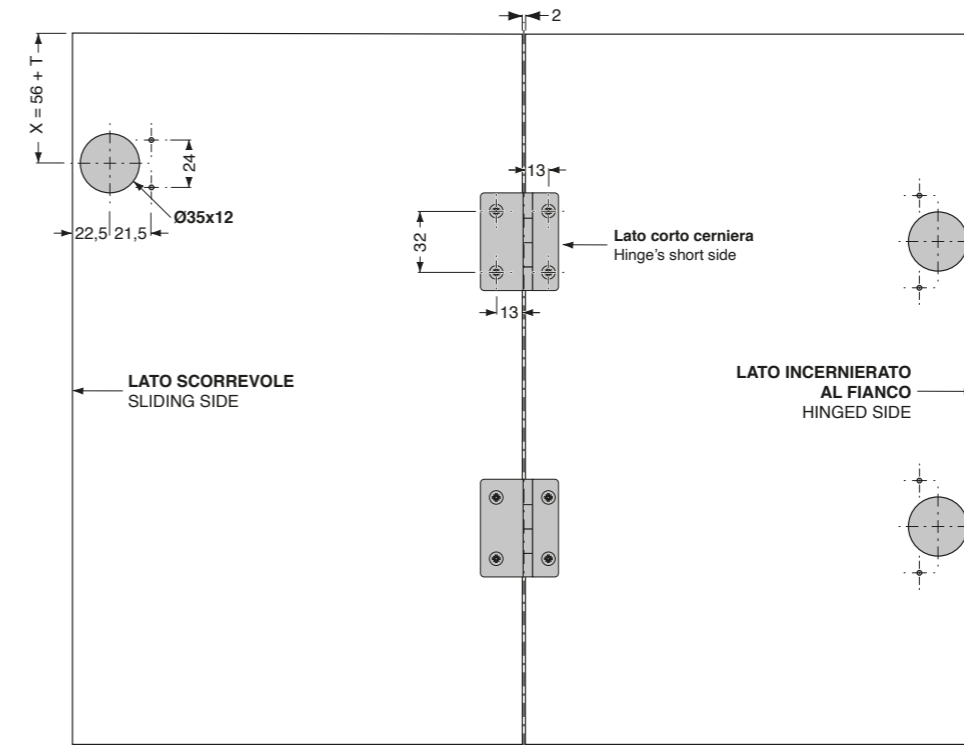

option
1

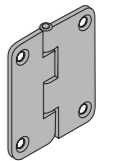

CL01105042

ABBREVIAZIONI:
T = spessore fondo/cappello
ABBREVIATIONS:
T = top / bottom panel thickness

■ **Cerniere centrali regolabili.**
Adjustable central hinges.

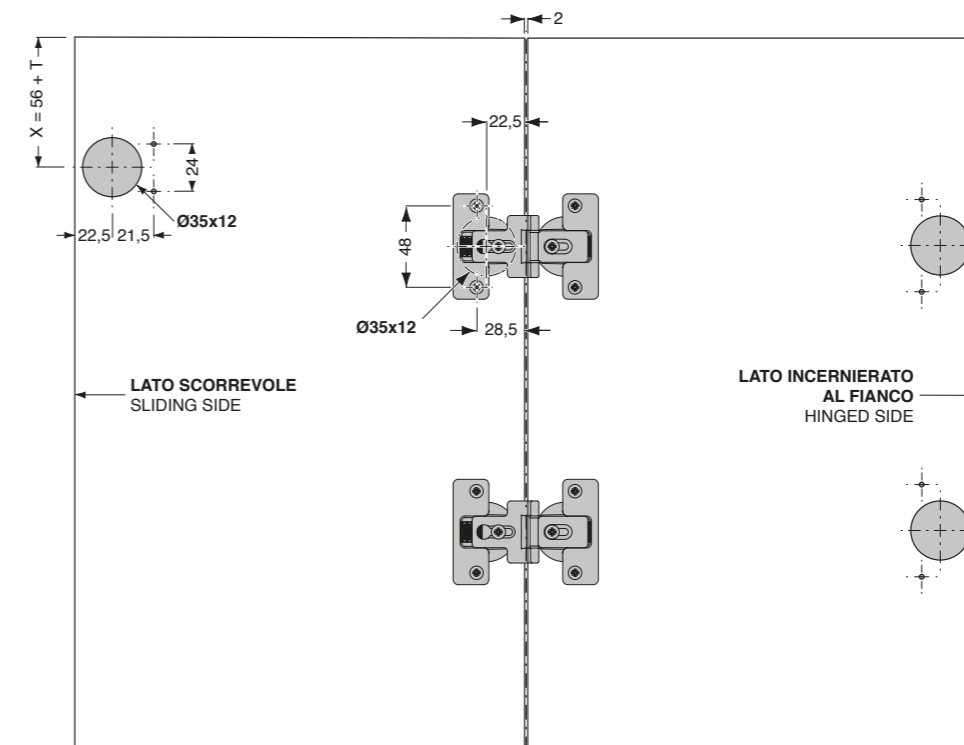

option
2

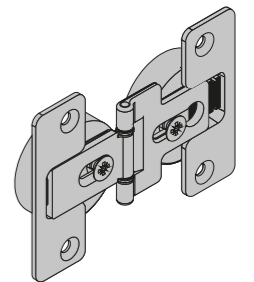

CL01420035

PS23

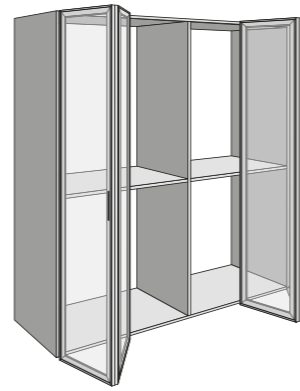
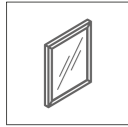

PS23 - 50

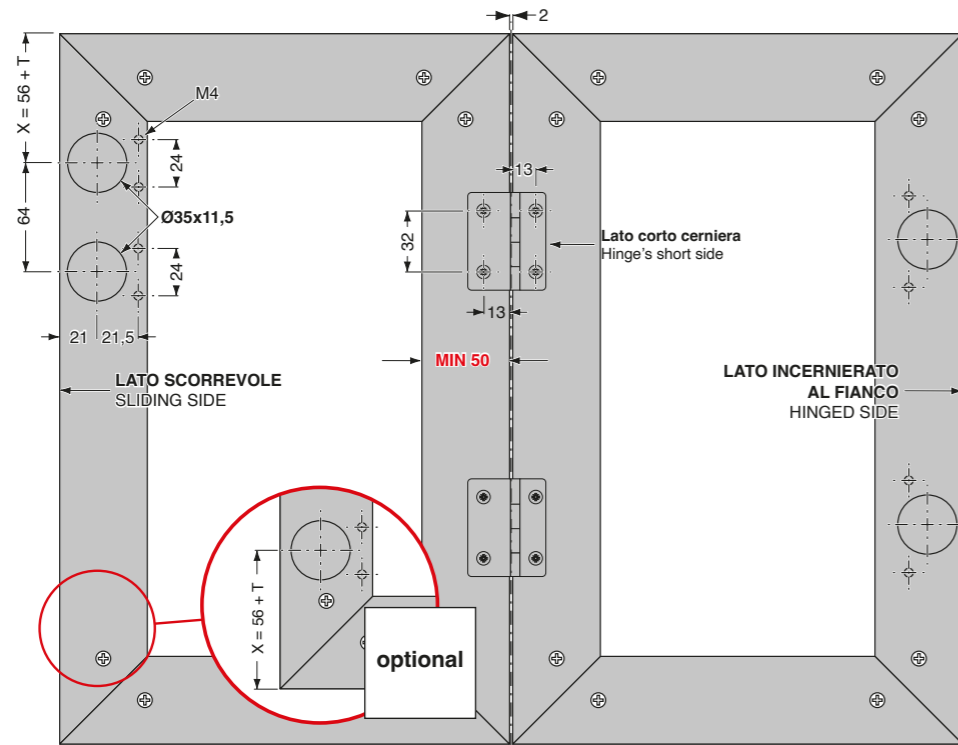

PS23 - 25

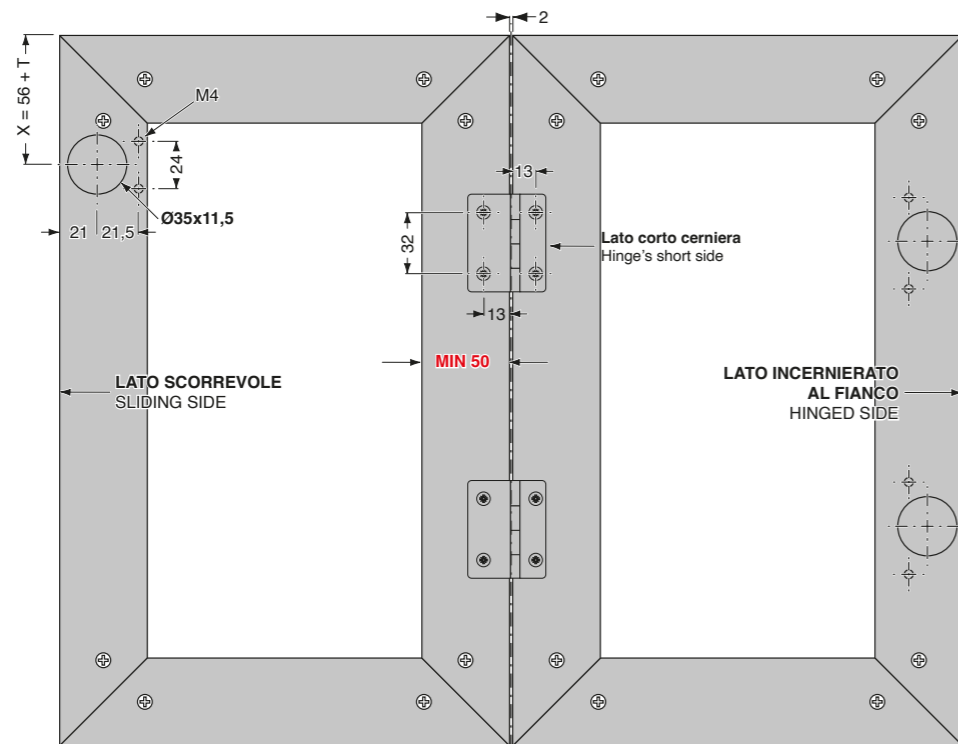

PS23. Schede tecniche / Data sheets

1

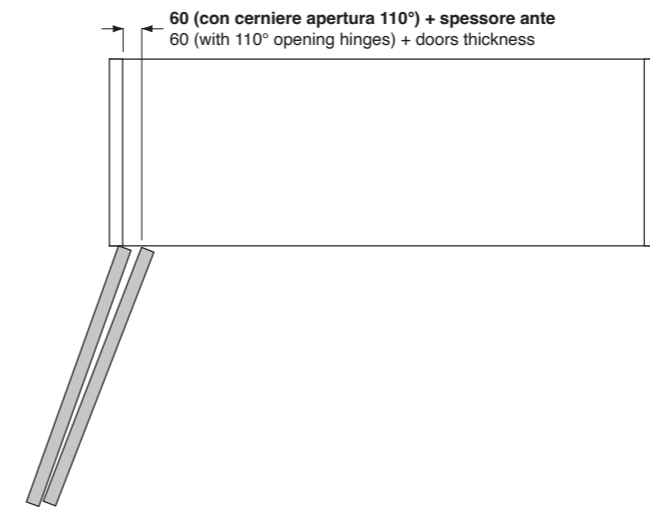
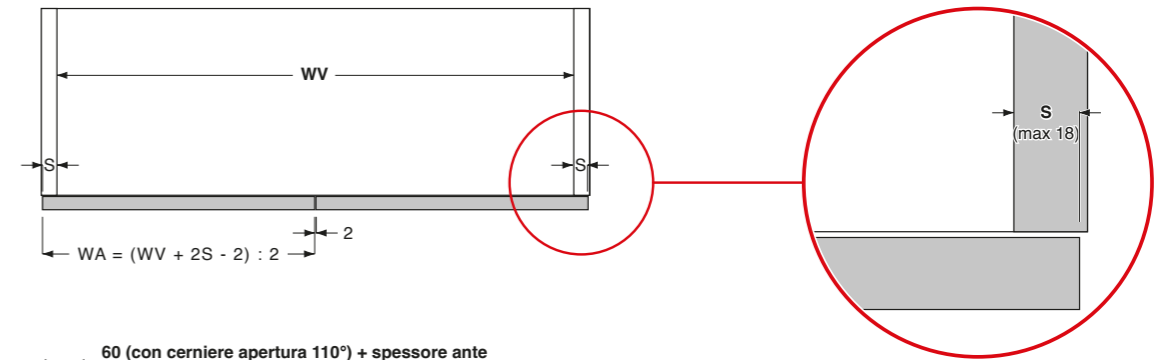

ABBREVIAZIONI:	
WA	= larghezza semi-anta
WV	= larghezza vano armadio
S	= sormonto
ABBREVIATIONS:	
WA	= half-door width
WV	= cabinet compartment width
S	= overlapping

2

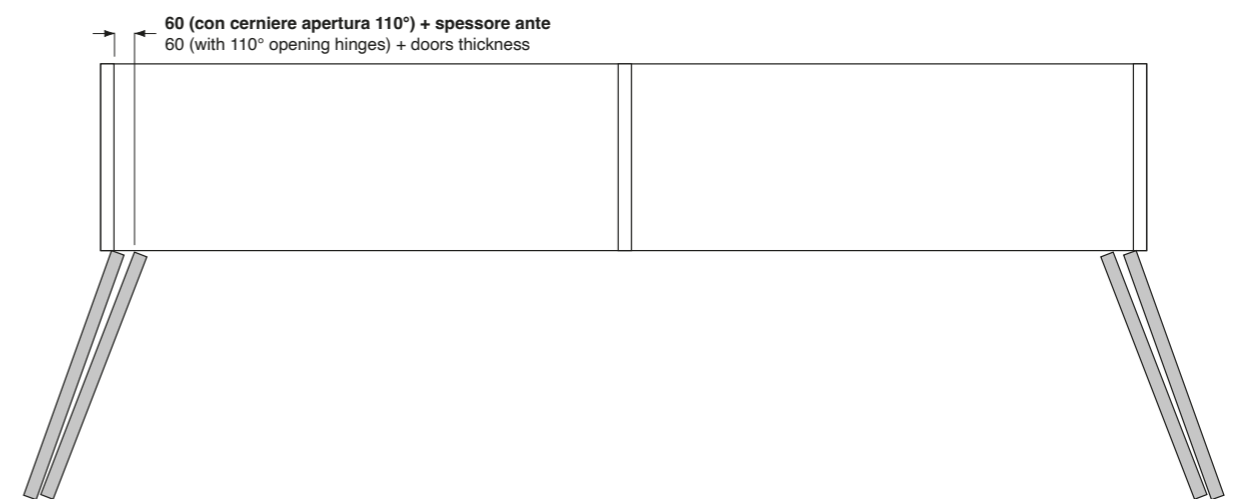
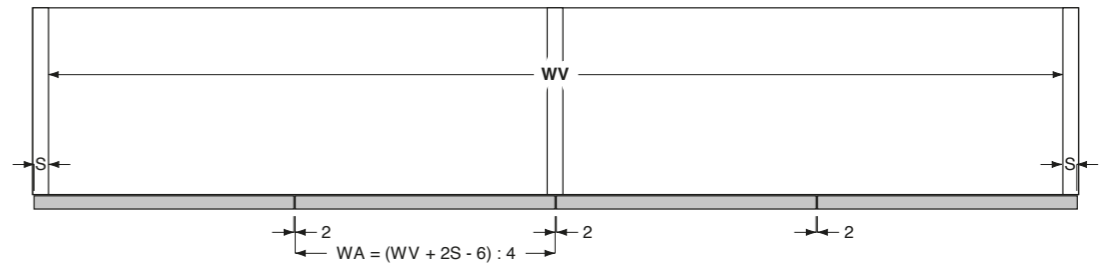

Lista componenti / Parts list

PS23 - 50

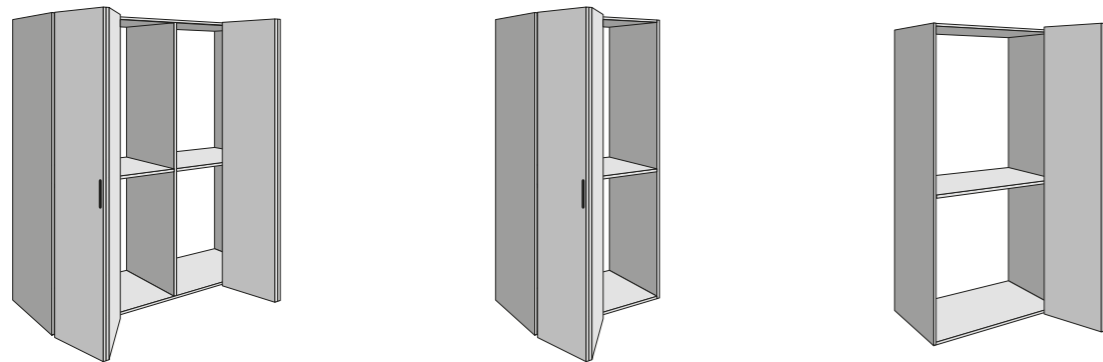

PR2370001A

Binario superiore.

Upper rail.

Finiture standard / standard finishes
Anodizzato / anodized: Silver, Black

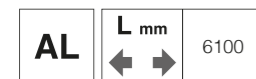
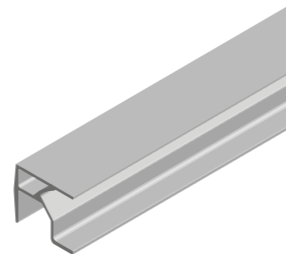
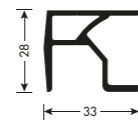

PS23KS1001

Confezione pattino superiore.
Finitura: Zincato

Kit of upper slide.
Finish: Zinc plated

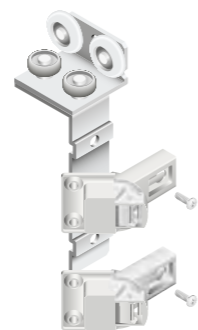

PS23KS1002

Confezione pattino superiore.
Finitura: Zincato

Kit of upper slide.
Finish: Zinc plated



PS23. Lista componenti / Parts list

PS23CO8E01 Metalized grey

PS23CO9001 Black

Scatola copricerniere.

Plastic cover.

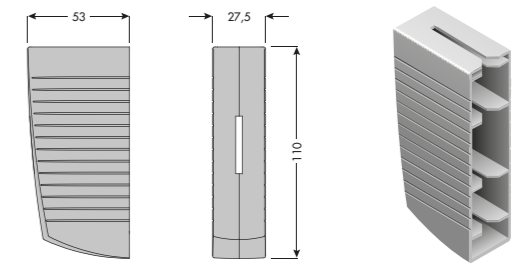

PL

CL01105042 Zinc plated

CL01125042 Black zinc plated

Cerniera asimmetrica.

Asymmetric hinge.

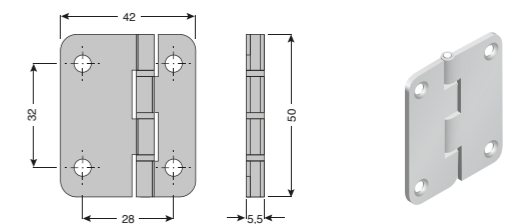

option
1 FE

CL01420035

Cerniera centrale regolabile.
Finitura: Nichelato satinato

Adjustable central hinge.
Finish: Satin nickel



option
2

PR557015150020

Binario inferiore.

Lower rail.

Finiture standard / standard finishes
Anodizzato / anodized: Silver, Black

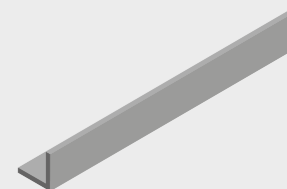
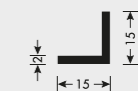

PS23KI1001

Confezione pattino inferiore.
Finitura: Grigio

Kit of lower slide.
Finish: Grey

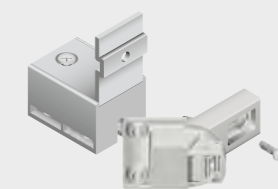

PL

PS23 - 25

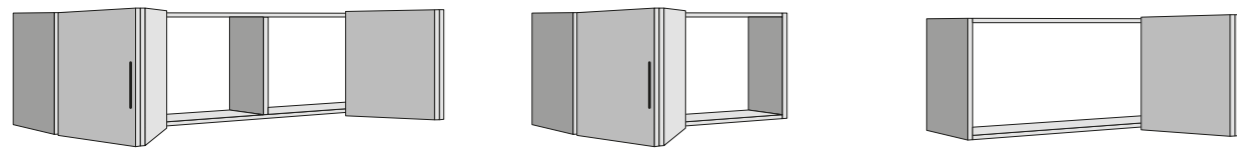

PR2370001A

Binario superiore.

Upper rail.

Finiture standard / standard finishes
Anodizzato / anodized: Silver, Black

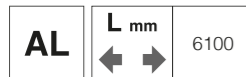
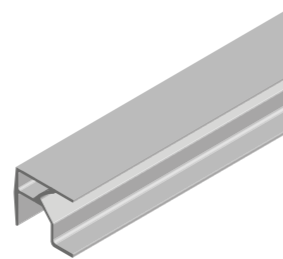
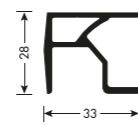

PS23KS1003

Confezione pattino superiore.
Finitura: Zincato

Kit of upper slide.
Finish: Zinc plated

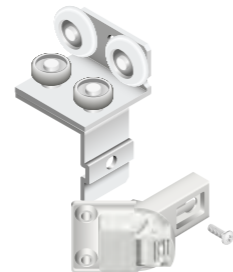

PS23KS1004

Confezione pattino superiore.
Finitura: Zincato

Kit of upper slide.
Finish: Zinc plated

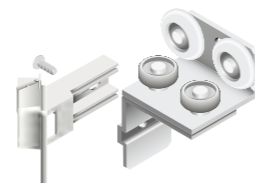

PS23CO8E04

Scatola copricerniera.
Finitura: Grigio metallizzato

Plastic cover.
Finish: Metalized grey

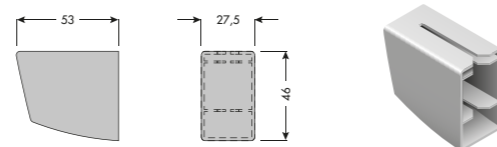

PS23. Lista componenti / Parts list

CL01105042 Zinc plated

CL01125042 Black zinc plated

Cerniera asimmetrica.

Asymmetric hinge.

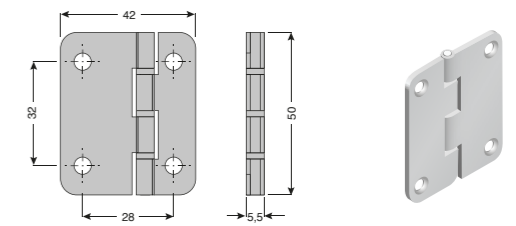

CL01420035

Cerniera centrale regolabile.
Finitura: Nichelato satinato

Adjustable central hinge.
Finish: Satin nickel



Accessori complementari Additional accessories

BR

Raddrizza ante.

Doors straightener.

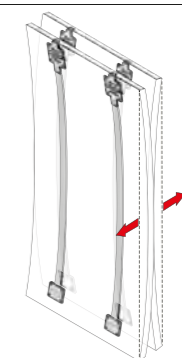

PR20

Ante in alluminio.

Aluminium doors.





Non utilizzare spray ed oli anti frizione o sblocca filetti sui cuscinetti o sulle ruote con O-ring dei pattini scorrevoli. Questo provoca lo scioglimento dei grassi dei cuscinetti rendendoli rumorosi oppure la rottura dell'O-ring.

Do not use any anti-friction oil or grease or thread-release spray on ball bearing or on wheels with O-ring, it can cause the melting of the inside ball bearing grease, making them noisy or causing the break of the O-ring of the wheels.

Tutte le parti del catalogo sono di proprietà della Cinetto F.lli S.r.l.

È vietata qualsiasi imitazione e copia delle illustrazioni, della grafica e la riproduzione, anche parziale, del presente catalogo senza autorizzazione.

I disegni tecnici e le informazioni dimensionali, incluse le illustrazioni, riportate in questo catalogo non sono vincolanti. L'azienda si riserva il diritto di apportare modifiche a fini migliorativi. Tutte le dimensioni sono in mm, se non diversamente specificate.

Si declina ogni responsabilità per errori di stampa.

All constituents of the catalogue are the property of Cinetto F.lli S.r.l.

Reprint of the catalogue or extracts thereof, reprinting or imitation of the illustrations or imitation of the design is forbidden without permission.

The technical representations and dimensional information in this catalogue are non-binding, including those in the illustrations and drawings. Right reserved to make design improvements. All dimensions are in mm unless otherwise specified.

No liability accepted for printing errors of the catalogue.

Rilasciato da - Issued by
Cinetto F.lli S.r.l.
Via Meucci, 4 - 35030 Rubano (PD) Italy

Tel. +39 049 8977211 - Fax +39 049 635822

Internet: www.cinetto.it - Email: info@cinetto.it

Novembre 2022
© by Cinetto F.lli S.r.l.
All rights reserved.
Printed in Padova - Italy



Sede Legale e Officina di Produzione

Via Meucci, 4 - 35030 Rubano (PD) Italy

www.cinetto.it - info@cinetto.it

Sede Amministrativa, Magazzino e Punto Vendita

Via Rossi, 5/A - 35030 Rubano (PD) Italy
Tel. +39 049 8977211 - Fax +39 049 635822
C.F./P.I. (VAT) (IT) 00277120283

